

**Kalamazoo
Packaging
Systems**
Division of Kal-Tek, Inc.

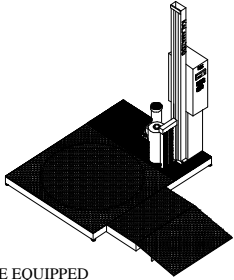

SCALE EQUIPPED
STRETCH WRAPPER

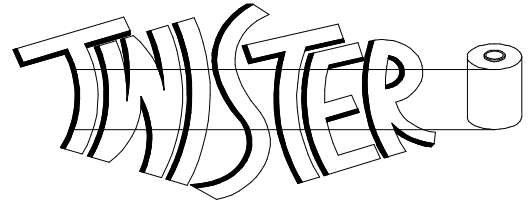
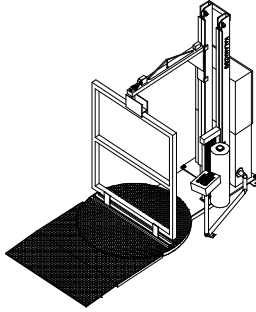

WINDOW/PANEL
WRAPPER

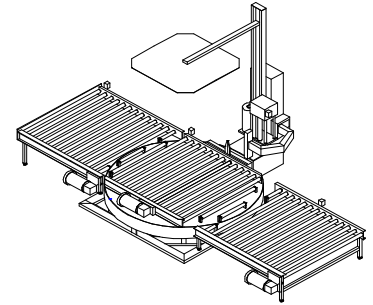

FULLY AUTOMATIC SYSTEM

****Fax Cover Sheet****

Proposal:

Pages to follow: 2

Date: 09/07

To :

Attn:

Fax #:

Phone #:

E-mail:

From: Ty Ferris

Subject:

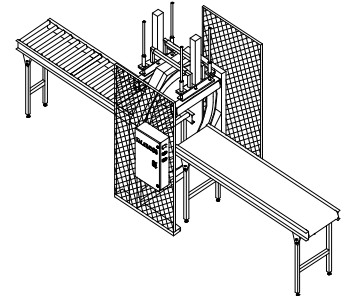

HORIZONTAL WRAPPER

Information and Quote
on our Model
618-W Wood Bundler Stretch Wrapper

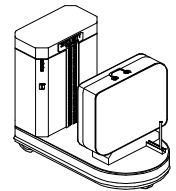

BAG WRAPPER

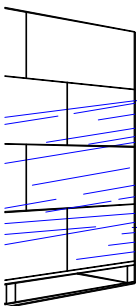

Practical Solutions to your Stretch Wrapping Problems.

P.O. Box 88141
Grand Rapids, MI 49518

Local (616) 534-2600
National (800) 253-4625

Fax (616) 534-4131
E-mail kzoo@iserv.net

For custom modifications or special applications, please consult factory

Visit us on the web!!

WWW.KALPACK.COM

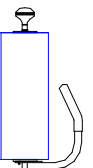

HANDWRAPPER

Kalamazoo Packaging Systems

Division of Kal-Tek, Inc.



SHOWN WITH OPTIONAL FREE STANDING BASE

SUBJECT: Model #618-W Wood Bundler Stretch Wrapper.
Maximum Bundle = 16" long " x 12" diameter

DESCRIPTION: Manual horizontal wrapper to stretch wrap fire wood bundles. A product pan to hold piece of wood 16" long to make into 12" diameter bundles. 12"-18" stretch film with film core braking system. No power required.

Kalamazoo is pleased to quote

Model #618-W Wrap-Master \$ 1,750.00

Available Options:

Free Standing Base (#618-009)	\$ 150.00
Dolly Wheels for easy movement (#618-011)	\$ 225.00
Larger product pan	consult factory
18" Stretch film 4ea. per box	consult factory

....THIS PROPOSAL IS GOOD FOR 60 DAYS....

Delivery: 2-3 weeks approximately

Terms: 25% Deposit, Balance 1% 10 Net 30 Days

F.O.B.: Grand Rapids, Michigan 49509

Submitted by : _____

Charles C. Rencurrel, President
(618-W page 1 of 2)

Practical Solutions to your Stretch Wrapping Problems.

P.O. Box 88141	Local (616) 534-2600	Fax (616) 534-4131
Grand Rapids, MI 49518	National (800) 253-4625	E-mail kzoo@iserv.net
For custom modifications or special applications, please consult factory		

Visit us on the web!!

WWW.KALPACK.COM

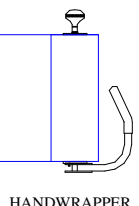

HANDWRAPPER

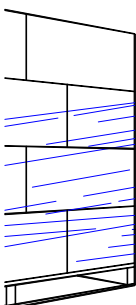

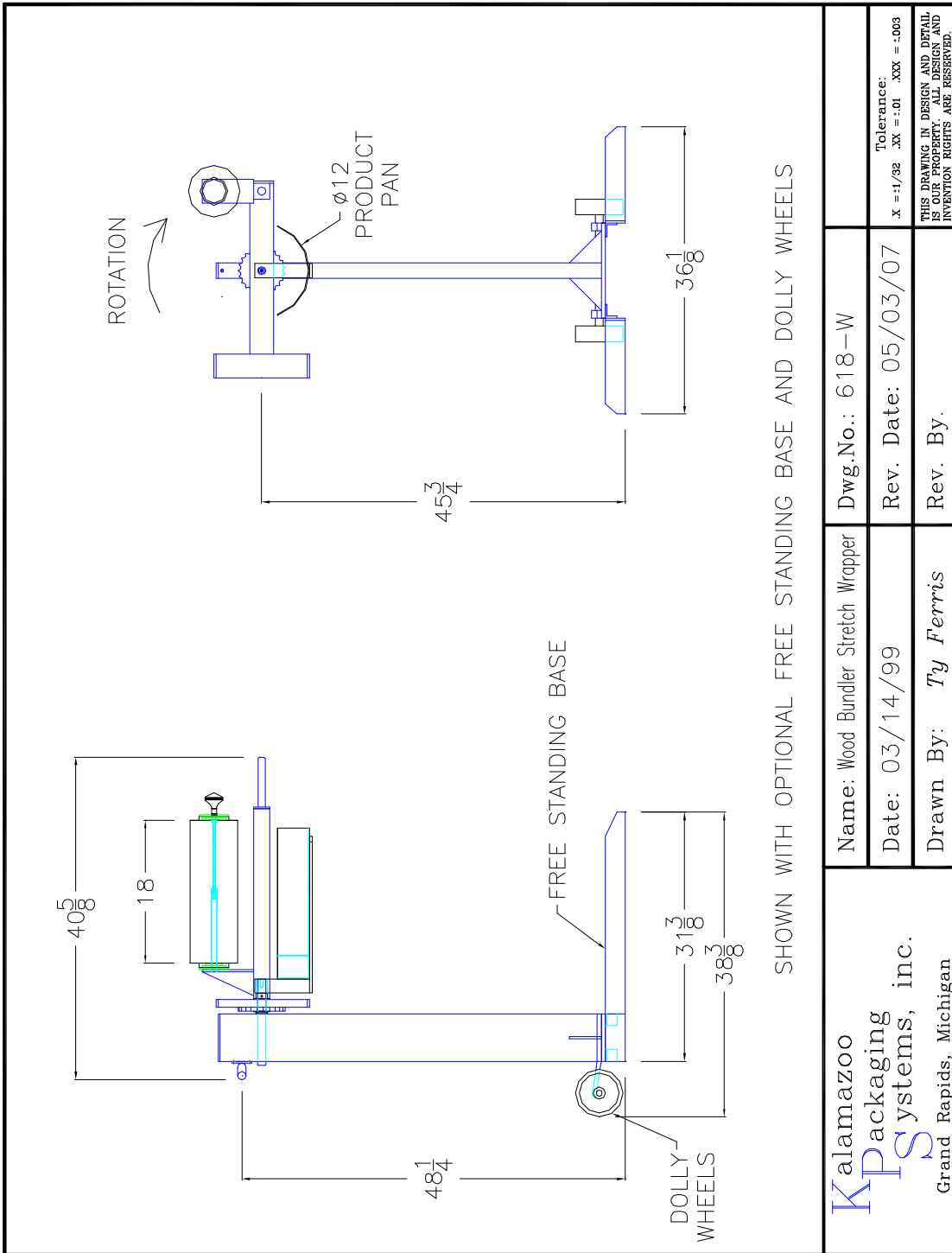

Kalamazoo
KPSackaging
 ystems, inc.
 Grand Rapids, Michigan

Name: Wood Bundler Stretch Wrapper

Date: 03/14/99

Drawn By: *Ty Ferris*

Dwg.No.: 618-W

Rev. Date: 05/03/07

Rev. By.

Tolerance:
 X = ±1/32 .XX = ±.01 .XXX = ±.003

THIS DRAWING IN DESIGN AND DETAIL IS OUR PROPERTY. ALL DESIGN AND INVENTION RIGHTS ARE RESERVED.